

ONDA

Polski

UWAGA!

Upadek mebla może spowodować poważne lub śmiertelne obrażenia. Aby zapobiec upadkowi mebla, należy go używać z dołączonymi mocowaniami do ściany.

Oceń jakość ściany, aby upewnić się, że wytrzyma powstałe obciążenia. Użyj wkrętów i kołków odpowiednich dla danego typu ściany i przewidzianego obciążenia. W razie wątpliwości zasięgnij porady profesjonalisty. Przeczytaj uważnie każdy punkt instrukcji i postępuj zgodnie z nimi.

English:

WARNING!

A falling piece of furniture can cause serious or fatal injuries. To prevent the furniture from falling, it should be used with the wall fixings provided.

Assess the quality of the wall to ensure it can withstand the applied loads. Use screws and dowels suitable for the wall type and the intended load. If in doubt, seek advice from a professional. Read each instruction point carefully and follow them accordingly.

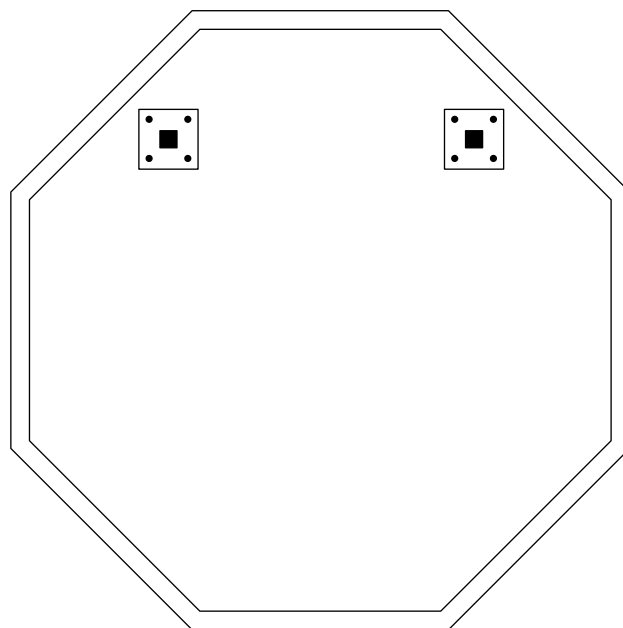
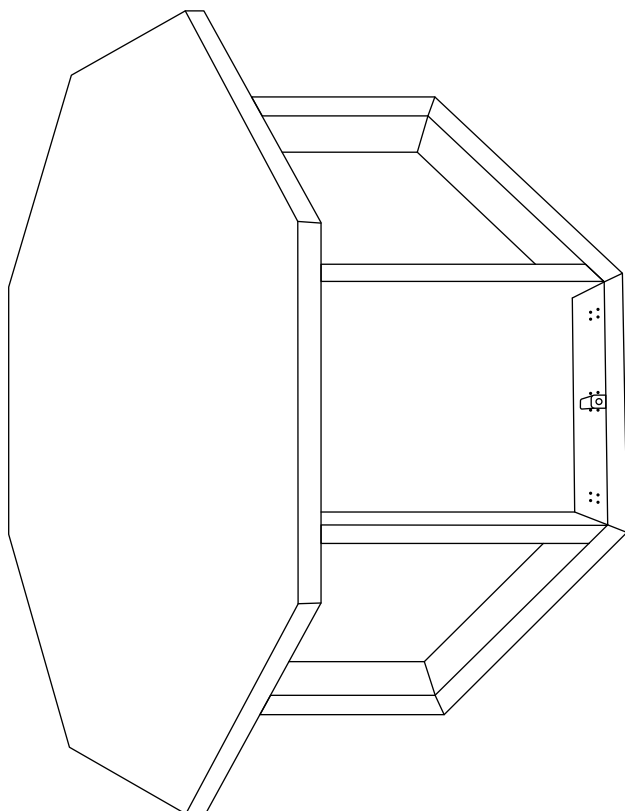

INSTRUKCJA

Uwaga!

Zalecany montaż produktu na ścianach z: betonu, żelbetonu, cegły ceramicznej, betonu komórkowego. Na ścianach wykonanych z innych materiałów zalecane wzmocnienie oraz zastosowanie kołków spoza zestawu, tak aby hak trzymał się mocno.





W zestawie:

2 sztuki kołków montażowych do ścian: betonowych, cegły dziurawki, stropów Teriva, cegły ceramicznej pełnej, betonu komórkowego

2 sztuki haków wkręcanych



Narzędzia potrzebne do montażu:

-  poziomica
-  młotek
-  wiertarka udarowa (wiertło 8mm)
-  kombinerki
-  miarka

Attention!

Recommended installation of the product on walls made of: concrete, reinforced concrete, ceramic brick, aerated concrete. For walls made of other materials, it is recommended to reinforce and use dowels not included in the set to ensure a secure hook attachment.





In the set:

2 pieces of assembly dowels for walls: new concrete, perforated bricks, Teriva ceilings, solid ceramic bricks, aerated concrete

2 pieces of screw-in hooks











Tools needed for assembly:

-  spirit level
-  hammer
-  impact drill (8mm drill)
-  pliers
-  measuring tape



INSTRUKCJA

- | | | | |
|---|---|---|---|
| <p>① Wyznacz wysokość, na której ma być zawieszona półka.</p> |  | <p>① Determine the height at which the shelf is to be hung.</p> |  |
| <p>② Za pomocą ołówka zaznacz na ścianie miejsca na otwory. Użyj poziomicy.</p> |  | <p>② Use a pencil to mark the places for the holes on the wall. Use a spirit level.</p> |  |
| <p>③ Wywierć otwory wiertarką.</p> |  | <p>③ Drill holes with a drill.</p> |  |
| <p>④ Wbij kołki młotkiem i wkręć haki kombinerkami.</p> |  | <p>④ Hammer in the mounting dowels with a hammer and screw in the hooks with pliers.</p> |  |
| <p>⑤ Zawieś mebel na ścianie.</p> | | <p>⑤ Hang the piece of furniture on the wall.</p> | |
| <p>⑥ Zamontuj drzwiczki wybierając lewy lub prawy kierunek otwierania.</p> | | <p>⑥ Mount the door with the option to choose either left or right opening direction.</p> | |

